

## MODULAR SCAFFOLDING , focused on flexibility, adaptable to any facada shape

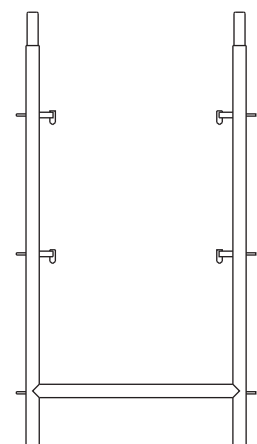
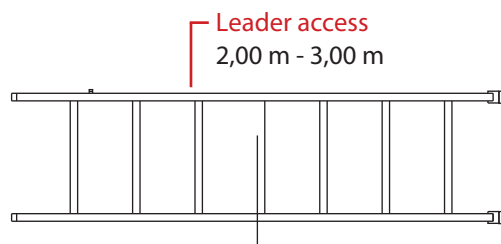
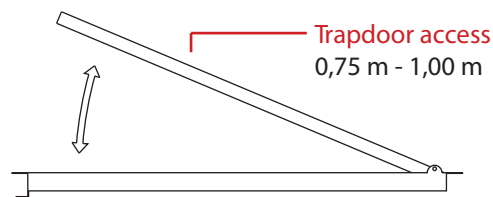
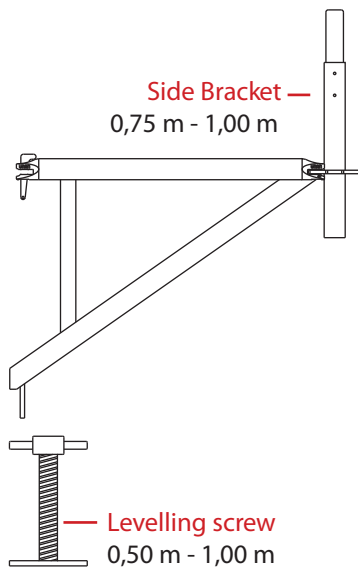
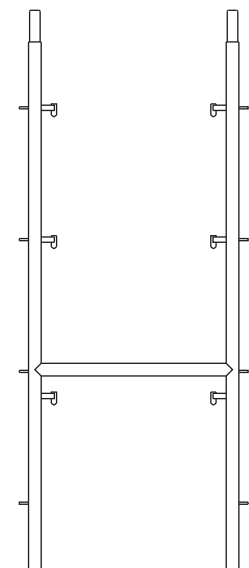
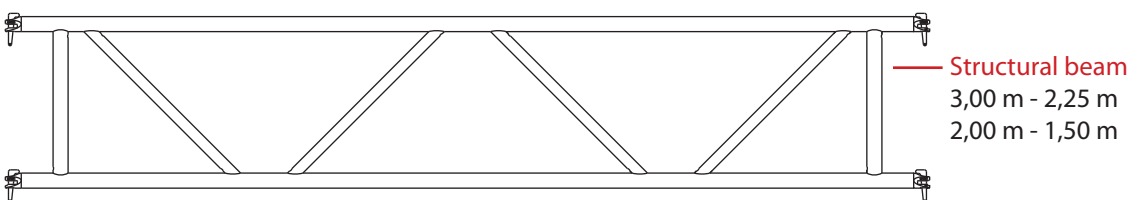
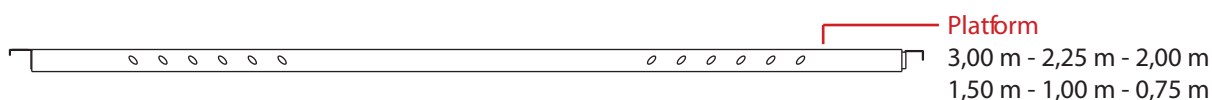
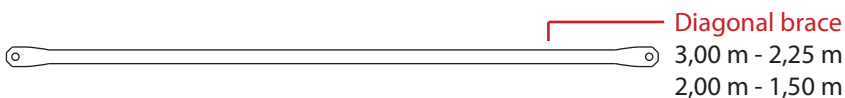
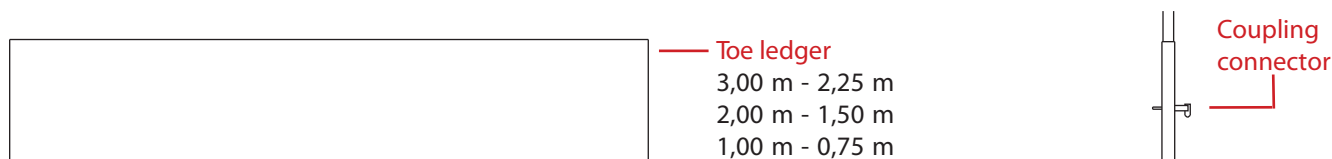

### UNAN CLASSIC - TECHNICAL SPECIFICATIONS

- PLATFORMS are made on galvanize steel perforated antiskid and supporting 250 Kg / m<sup>2</sup>
- THIS SYSTEM IS designed to be installed fast and in a very easy way, especially indicated for facade.
- OUR H FRAME include a protection system during the installation according with the most strict regulations.
- This system elements are 100% compatible with MULTI-UNAN system so our clients can interchange the elements on the same jobsite.
- MODULAR SYSTEM manufactured using structural pipes 48 mm and 42 diameter